

# Fitting Instructions

## Revo Intercooler Kit 2.5 TFSI TTRS (FV)

Fitting Difficulty



Dealer Fit Recommended

### Contents

Description	Quantity
Revo Intercooler	1
Revo Throttle Hard Pipe	1
Revo Upper Throttle Hose	1
Revo Lower Throttle Hose	1
Revo Discharge Hose	1
60-80 Hose Clamp	6
Spacer Plate	1
Cable Tie	2

### Recommended Tools

Tools	Size
Ratchet	
Extension	
Sockets	7mm, 8mm, 10mm, 16mm
Torx Bits	T25, T30, T45
Flat Head Screwdriver	Medium
Hydraulic Jack/Gearbox Stand	
Block of Wood	50x100mm or equivalent



Before starting, please ensure that the engine is cool and the battery is disconnected. Engine temperatures can remain high for a substantial amount of time after use.

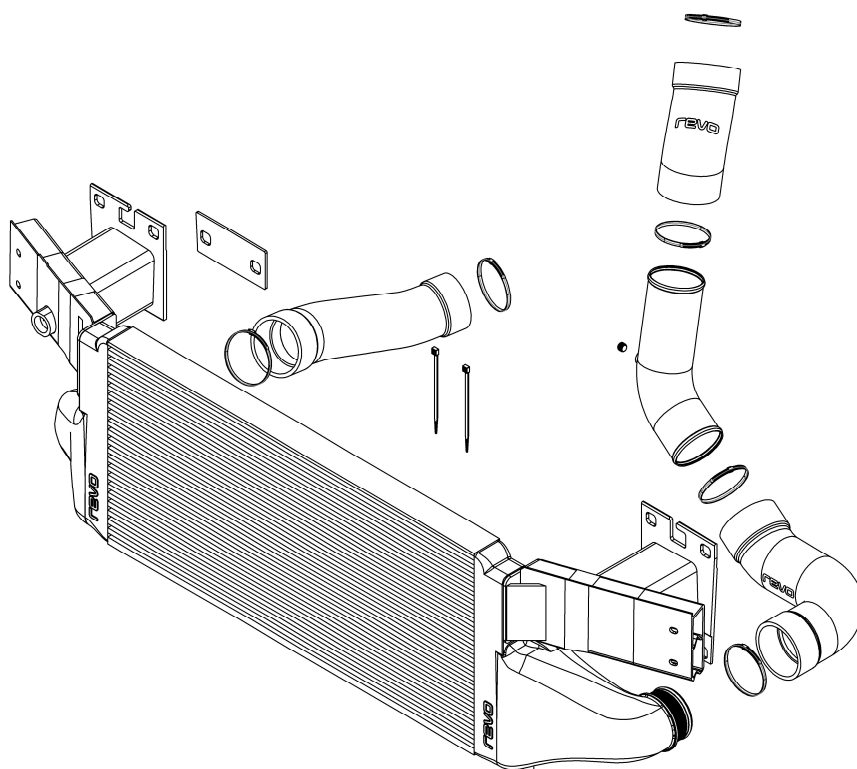

# Fitting Instructions

## Revo Intercooler Kit 2.5 TFSI TTRS (FV)

Fitting Difficulty



Dealer Fit Recommended



Installation was performed on a UK-spec. TTRS (FV). Installation on other vehicles will be similar but may not be exact.

- 1 Raise vehicle to gain access to the underside.

- 2 Remove the undertray from the vehicle.

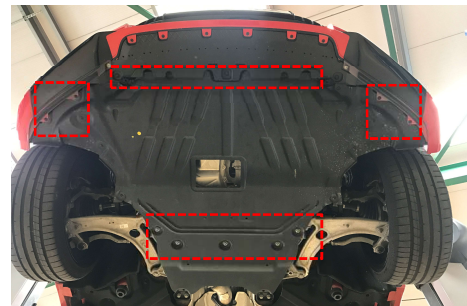

- 3 Using a T25 socket, remove the 3 x screws from each wheel arch lining to gain access behind the bumper.



- 4 Disconnect the parking sensor plug that is situated behind the bumper at right, as shown. Pull out the red tab and squeeze the plug while pulling to disconnect it.

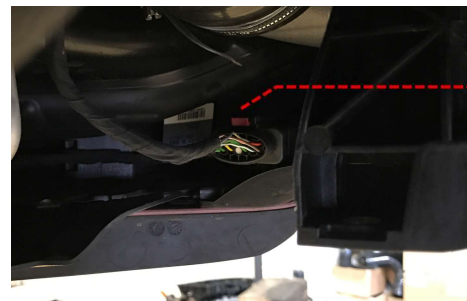

# Fitting Instructions

## Revo Intercooler Kit 2.5 TFSI TTRS (FV)

Fitting Difficulty



Dealer Fit Recommended

- 5 Use a T25 socket to remove the screw that secures the bumper to the front wing. Repeat for the opposite side.

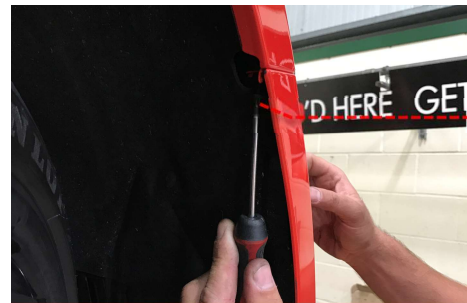

- 6 Remove the bonnet release handle by pushing the release button, found at the 12 o'clock position, and pulling up on the handle.

Note: once the bonnet release handle is removed, do not close the bonnet without refitting the handle first.

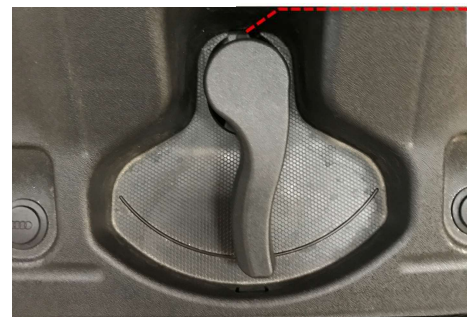

- 7 Use a flat head screwdriver to remove the 6 x plastic clips from the top bumper trim and place out of the workspace.

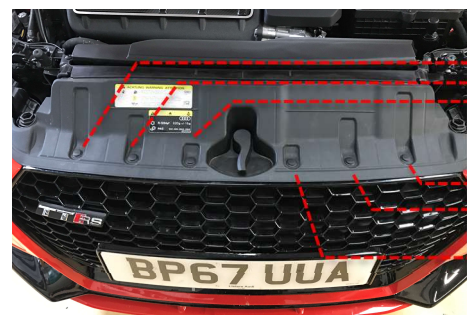

- 8 Use a T25 socket to remove the 2 x screws that secure the front air intake and slide it out of the airbox. Place it out of the workspace.

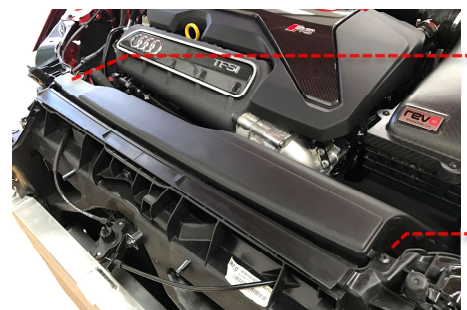

# Fitting Instructions

## Revo Intercooler Kit 2.5 TFSI TTRS (FV)

Fitting Difficulty



Dealer Fit Recommended

- 9 Remove the front bumper from the vehicle by carefully pulling each side away from the wing as shown.

Note: with one person either side of the bumper, remove the front bumper and store safely so as not to damage any paintwork.

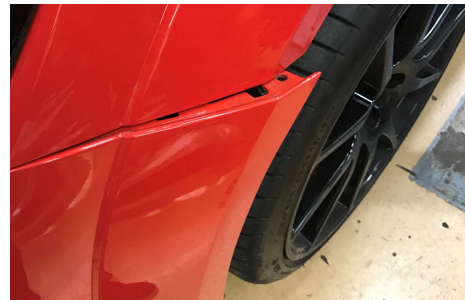

- 10 Use a T30 socket to remove the 3 x bolts from the top of each headlamp. Next, disconnect the plug at the rear of the headlamp unit. Repeat on the opposite side of the vehicle.

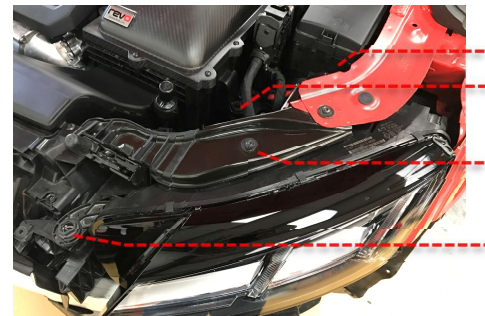

- 11 Use a T30 socket to remove the 2 x bolts from the underside of the headlamp and remove the plastic bracket. The headlamp can now be removed from the vehicle. Repeat on the opposite side and remove the remaining headlamp from the vehicle. Place both headlamps out of the workspace.



- 12 Remove the 2 x radiator ducts from the front of the vehicle by pulling them downwards, out of their clips. Place both ducts out of the workspace.

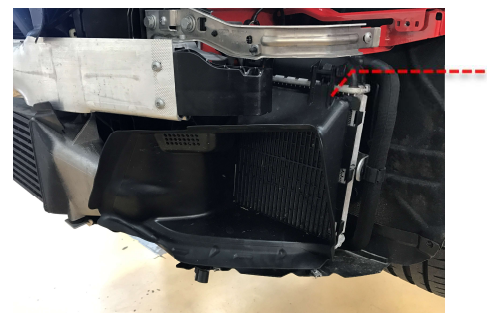



# Fitting Instructions

## Revo Intercooler Kit 2.5 TFSI TTRS (FV)

Fitting Difficulty



Dealer Fit Recommended

- 13 Use a 7mm socket to loosen the hose clamp on the OE discharge hose and remove it from the intercooler. Repeat for the throttle hose on the opposite side. Use a 10mm socket to remove the nut that holds the OE throttle hard pipe to the oil pan stud. Do not remove any parts at this time.

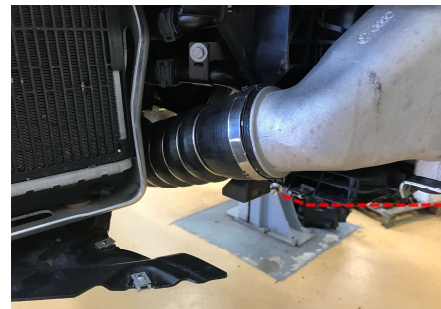

- 14 Use a T30 socket to remove the 2 x bolts from the top of the intercooler.

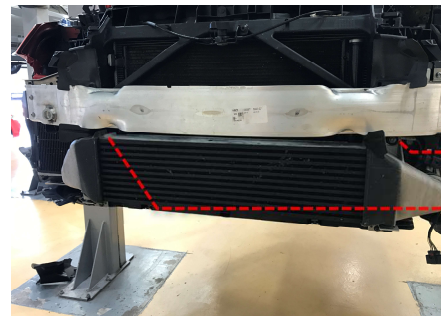

- 15 Disconnect the ambient temperature sensor plug, shown in the picture, by squeezing the clip and pulling apart.



- 16 Use a T30 socket to remove the 2 x screws from the bottom intercooler brackets. Remove the brackets from the vehicle and then completely remove the OE intercooler. Place it out of the workspace.



# Fitting Instructions

## Revo Intercooler Kit 2.5 TFSI TTRS (FV)

Fitting Difficulty



Dealer Fit Recommended

- 17 Disconnect the plug for the horn (not shown) and crash sensor on each side of the vehicle. To disconnect the crash sensor, pull out the red tab to disconnect the plug.



- 18 Use a T30 and 16mm socket to remove the 2 x screws and bolt from the horn bracket and remove from the vehicle. Repeat for the other side and set both brackets out of the workspace.

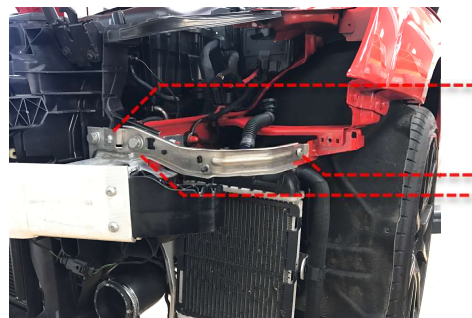

- 19 Use a T30 socket to remove the 2 x screws that secure the crash bar end cap and remove from each side of the bar. Set both out of the workspace, they will be reused.

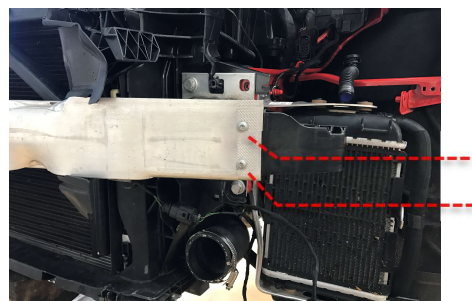

- 20 Remove the ambient temperature sensor by gently pulling it out of the shroud.

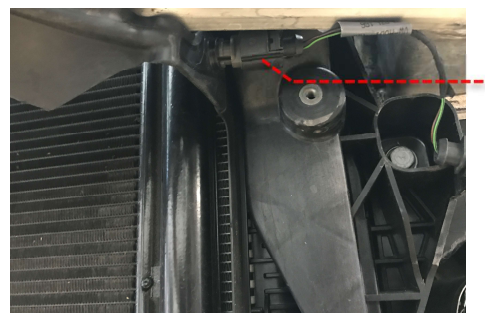

# Fitting Instructions

## Revo Intercooler Kit 2.5 TFSI TTRS (FV)

Fitting Difficulty



Dealer Fit Recommended

- 21 Use a gearbox stand/jack with a large block of wood to support the radiator assembly.

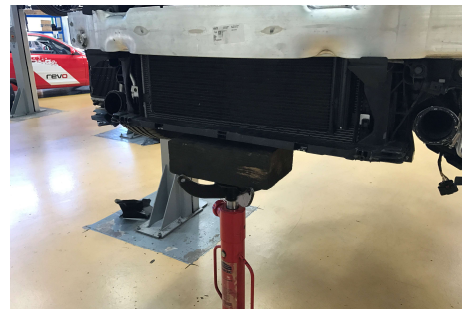

- 22 Use a 16mm socket remove the remaining 6 x 16mm bolts that secure the crash bar in place. Lift the crash bar upwards, tilt it towards the front of the vehicle and remove completely.

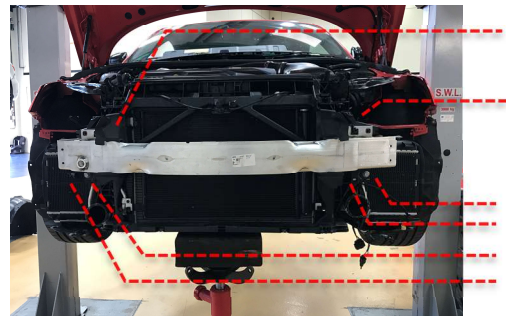

- 23 Position the Revo intercooler to line up with the holes in the chassis rails for the crash bar bolts. Place the bottom of the Revo intercooler brackets behind the radiator support brackets, tilt the intercooler so that the throttle side crash bar plate sits behind the core support, similar to OE. Next, slide the intercooler toward the discharge side to align the bolt holes. Install a bolt on each upper, outer side of the crash bar to temporarily hold the Revo intercooler on the vehicle.



- 24 Fit the spacer (supplied) below the discharge side crash bar chassis plate. Ensure the angled side of the spacer plate faces towards the outside of the vehicle. Use a 16mm socket to reinstall all crash bar bolts and tighten all bolts to factory torque specifications.

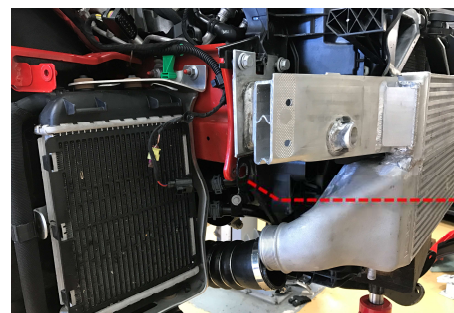



# Fitting Instructions

## Revo Intercooler Kit 2.5 TFSI TTRS (FV)

Fitting Difficulty



Dealer Fit Recommended

- 25 Use a 7mm socket to loosen the hose clamp on the discharge hose and remove it from the vehicle.



- 26 Use a 7mm socket to loosen the hose clamp that holds the throttle hose to the throttle body. Remove the OE throttle pipe assembly from the vehicle, through the bottom of the engine bay.



- 27 Fit the Revo discharge hose, making sure the hose clamps are positioned so they can easily be accessed. Rotate the Revo hose until the ends of each hose are flush to the Revo intercooler and OE discharge pipe faces. Once the faces are flush, use an 8mm socket to tighten both hose clamps.

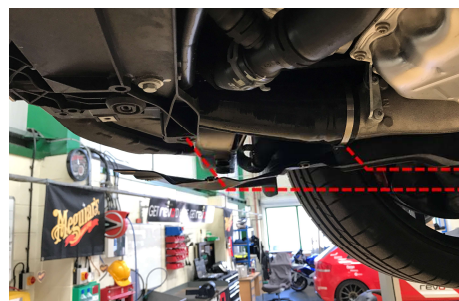

- 28 Install a hose clamp onto the shorter Revo hose of the throttle pipe assembly and align it so it is easily accessible when the hose is installed on the throttle body. Install the Revo hose onto the throttle body. The hose should angle slightly towards the wiring loom, as shown. Ensure the hose end sits flush against the throttle body face. Rotate the Revo hose to achieve both items above, then use an 8mm socket to tighten the hose clamp.

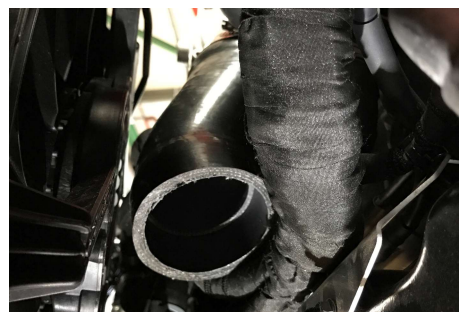

# Fitting Instructions

## Revo Intercooler Kit 2.5 TFSI TTRS (FV)

Fitting Difficulty



Dealer Fit Recommended

29 Install a hose clamp onto the opposite end of the Revo upper throttle hose, positioned so that the clamp can be tightened from the top of the engine bay. Install the Revo hard pipe into the Revo upper throttle hose. Install the remaining 2 x clamps onto the Revo lower throttle hose and install the remaining hose onto the Revo intercooler/hard pipe. Rotate the lower Revo hose and Revo hard pipe until the lower hose sits flush on the intercooler face and the Revo upper hose has >5mm clearance to the radiator fan at its closest point. Once proper alignment/clearance is achieved, tighten the remaining 3 x hose clamps with an 8mm socket.

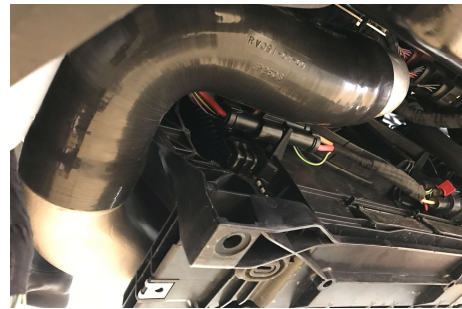

30 Use a flat head screwdriver to remove the 4 x clips that secure the bottom piece of foam inside the bumper and then remove the main bumper foam and the 2 x lower side foams from the bumper.

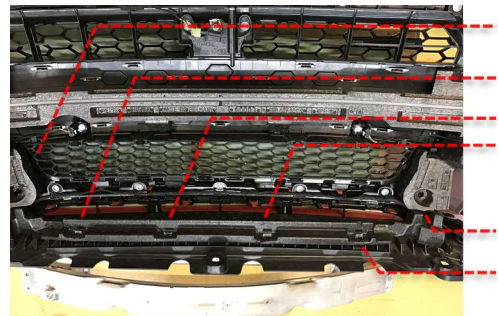

31 Using the 2 x cable ties (supplied), secure the clear tubing by inserting each cable tie through the clip holes in the bumper cover in the approximate locations shown.

Note: be careful not to overtighten the cable ties and pinch the pipe.



32 Remove the T30 bolt that secures the latch sensor in place on the inside of the bumper and remove the inner piece from the mechanism.





## Fitting Instructions

### Revo Intercooler Kit 2.5 TFSI TTRS (FV)

Fitting Difficulty



Dealer Fit Recommended

- 
- 33 Refit all OE parts back to vehicle. Reinstallation is the reverse of removal. Follow any factory torque specification during reinstallation of OE parts. Check all sensors/electrics are reconnected. Also check bonnet release handle is refitted. Test drive the vehicle to ensure vehicle performs correctly and there are no leaks/part interference during operation. Your installation is now complete!

# Fitting Instructions

Revo Intercooler Kit 2.5 TFSI TTRS (FV)

Fitting Difficulty



Dealer Fit Recommended

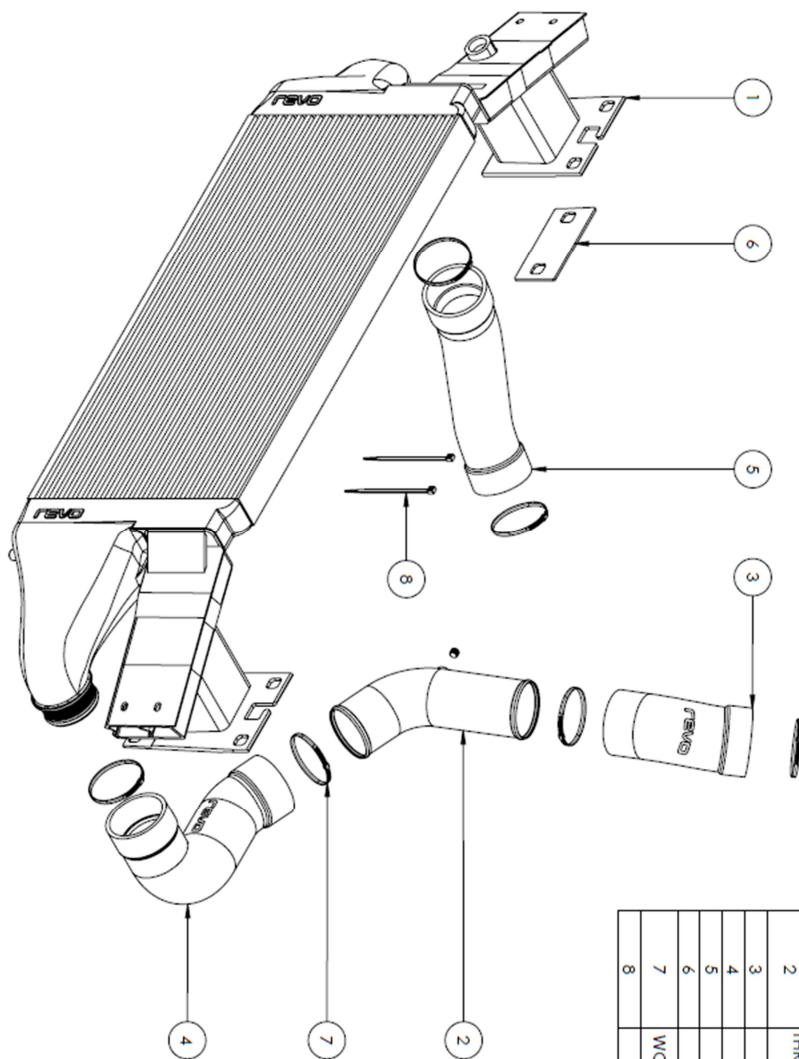

ITEM NO.	DESCRIPTION	QTY.
1	INTERCOOLER & CRASH BAR ASSEMBLY (COATED)	1
2	THROTTLER HARD PIPE ASSEMBLY (INCLUDES 1/8"-27 NPT STAINLESS STEEL PLUG)	1
3	THROTTLER PIPE THROTTLER SILICONE	1
4	INTERCOOLER OUTLET SILICONE	1
5	INTERCOOLER INLET SILICONE	1
6	INLET SPACER PLATE	1
7	WORM DRIVE 60-80MM STAINLESS STEEL HOSE CLAMP	6
8	1.30MM X 3.6MM CABLE TIE	2